

USER'S MANUAL



DY-GP Plus Cordless GP Obturation System

- *The unit must be installed by a qualified engineer.
- *Only for user by dental professionals.
- *Read this operation manual carefully before installation or operation.



Thank you for purchasing our device. Before operating the device, please fully read the manual and this manual should be saved for later use.

DENJOY DENTAL CO., LTD will take the responsibility for the security, reliability, capability under the following conditions:

1. The installation, debugging, maintenance should be adjusted by the approbatory technician by our company or obtained related nation quality level license professions.
2. The power supply shall be in conformity with the relevant provisions of the state and the use requirements of device itself.
3. The device should be operated by licensed dental professionals with medical applied skill. The whole operation process should follow user's manual strictly.

DENJOY DENTAL CO., LTD has right to improve shape and structure of the device, change any information and technical specification of this manual all the time, and no need to notice the user in advance.

CONTACT INFORMATION

The device is manufactured by:

DENJOY DENTAL CO., LTD

Address: F4, Building A4, Lugu Medical Device Park, No.229

Guyuan Road, Changsha, 410205 P. R. China

Website: www.denjoy.cn E-mail: denjoy@denjoy.cn

Phone: +86 731 85126543 Fax: +86 731 88885317

Authorized European Representative:

Company name: LANDLINK GMBH

Address: DORFSTRASSE 2/4, 79312 EMMENDINGEN, GERMANY

Please contact sales representative directly from whom you have bought this device for user's record and further after-sale service

CONTENTS

SECTION 1: GENERAL INTRODUCTION

SECTION 2: MAIN TECHNICAL INDEX

SECTION 3: SYMBOL

SECTION 4: PRODUCT STRUCTURE

SECTION 5: INSTALLATION AND SETTING

SECTION 6: INSTRUCTION OF OPERATION

SECTION 7: APPLICATION OF ROOT CANNAL FILLING

SECTION 8: CLEANING & MAINTENANCE

SECTION 9: TROUBLESHOOTING

SECTION 10: ENVIRONMENTAL REQUIREMENTS

SECTION 11: PACKING LIST

SECTION 12: WARRANTY STATEMENT

REMARKS:

The pictures here are for reference only.

Real products shall prevail.

The parameters and pictures in this manual are subject to change without prior notice.

SECTION 1: GENERAL INTRODUCTION

DY-GP Plus cordless gutta percha obturation system is a newly developed system which is composed of FreeFill pen, FreeFill gun and charging system. It provides accurate and predictable three-dimensional filling that will improve your efficiency as a clinician. The two function systems can be individually used or in adjunct with one another according to treatment conditions.

1.1 Fundamental

Convert electrical energy to heat energy for root canal filling.

1.2 Scope of Application and Intended Use

This device is suitable for root canal filling which caused by pulp necrosis, chronic pulpitis, chronic periapical inflammation (including periapical granuloma, periapical abscess and periapical cyst), dental pulp periodontal syndrome and need treatment but inappropriate for extraction because systemic diseases or who needs to keep the problem teeth temporarily.

1.3 Features

- Power display.
- Working status display.
- 360° all-direction heating.
- Use 0.9 inch OLED display.
- Reduced gutta-percha leakage.
- Fast heating and high efficiency.
- Faster heating for injection needle.
- Injection needle can be rotated 360°.
- There is a buzzer beep during operation.
- 6 adjustable directions for injection needle.
- Faster power charging, shorter charging time.
- Smart power saving mode offers longer operation.
- Light and more comfortable, more ergonomic design.
- All parts which touched the patients can be autoclaved.
- Two-in-one system makes filling easier and more convenient.
- Digital display of temperature regulation, it is more convenient.
- Special mode for changing injection needle and machine cleaning.

SECTION 2: MAIN TECHNICAL INDEX

Model Name	DY-GP Plus
Trade Name	FreeFill
Anti-shock type	Built-in power supply
Degree of protection against electric shock:	
- Type B applied part: 	
Operation mode	Continuous Operation
Power:	Injection Device: ≤10W Heating Pen: ≤10W

1) Charging System	1. Working voltage 2. Adapter 3. Charging time	Type: SMPS I/P: AC100~240V 50/60Hz O/P: DC7.5V 2.5A About 1.hours
2) Injection Device	1. Voltage 2. Temperature sensor 3. Temperature range	3.7Vdc Type: T 150°C、180°C、200°C、220°C
3) Heating Pen	1. Voltage 2. Temperature range	3.7Vdc 150°C、180°C、200°C、220°C
4) Operating Time	1. Injection device 2. Heating Pen	About 2 hours About 1 hour

※ **Notice: Special care is required for lithium battery in order to avoid any unnecessary trouble. Please read the information as follows:**

Specifications of battery

- 1) Capacity: 3.7 Vdc,
- 2) Input of charging base: 7.5Vdc, Output of charging base: 4.2Vdc
- 3) Operating condition:
Temperature: 5°C ~ 40°C Humidity: ≤80%
- 4) Transportation and storage condition:
Temperature: - 40°C ~ 55°C Humidity: ≤80%

 Batteries can not be placed near fire, recharged, put in backwards, mixed with used or other battery type to avoid explosion and electricity lead that will cause personal injury.



 There is the risk of explosion if battery is placed in an incorrect method. Replace only with the same type or equivalent type recommended by the manufacturer. Dispose of used batteries according to the local regulations.











 The injection device is designed to inject warmed gutta percha that is specially formulated into the root-canal directly. It's provides easy and fast filling, but it's recommended to use the pen to fill the apical part at first to avoid any overfilling or under filling and the injection device can be used for filling the remained part of the canal.

The Heating pen is designed for vertical condensation or down packing with warmed gutta percha in the canal. Besides, it can be used to cut off excessive gutta percha point.

SECTION 3: SYMBOL

The following symbols may appear in this manual, on the label, or on it's accessories. Some of the symbols represent standards and compliances associated with the device and its use.

	Consult accompanying documents
	Caution
	Authorized Representative in the European Community

	CE Mark: conforms to essential requirements of the Medical Device Directive 93/42/EEC.
	Sterilizable up to the temperature specified at most
	Date of manufacture.
	Manufacturer
SN	Specifies serial number
	Type B applied part
	Refer to instruction manual / booklet
	The device should not be used after the end of the shown or the day
	DISPOSAL: Do not dispose this product as unsorted municipal waste. Collection of such waste separately for special treatment is necessary.
	alert indicator displayed on the LCD screen
	Battery power indicator displayed on the LCD screen

SECTION 4: PRODUCT STRUCTURE

The whole system is composed of injection device, heating pen, charging system, and accessories.

The charging system includes charging base and adapter.

The accessories include heat insulator, brush, accessory tool, injection needles and heating tips.

Working voltage: 3.7V~4.2V Injection Device: ≤10W Heating Pen: ≤10W

Structure as blow:

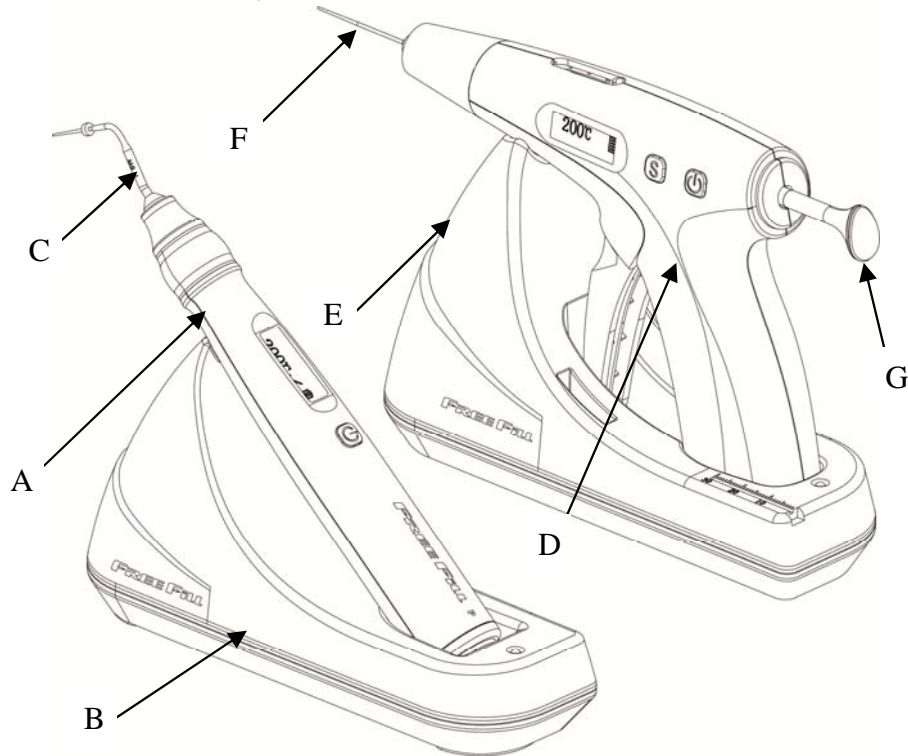

- A, FreeFill Obturation Pen/Heating Pen
- B, Charging Base for FreeFill Pen
- C, Heating Tip
- D, FreeFill Obturation Gun/Injection Device
- E, Charging Base for FreeFill Gun
- F, Injection Needle for Obturation Gun
- G, Plugger

Injection Device/FreeFill Obturation Gun

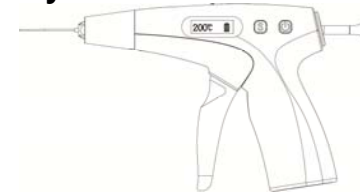

FreeFill Gun (Injection device)

For backfilling the melted gutta-percha

Plugger



Pushing gutta-percha outside of the needle

Status Description of the Plugger:

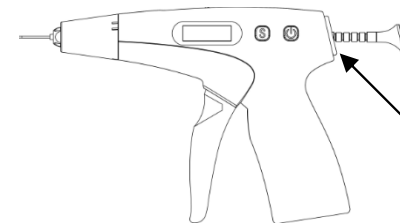

Gutta-percha is pushed inside of the injection needle, please start heating, and backfilling when set temperature reached

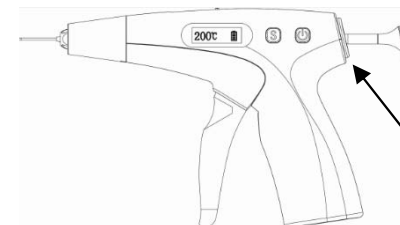

Gutta-percha is used up, please start the cleaning function or add gutta-percha.

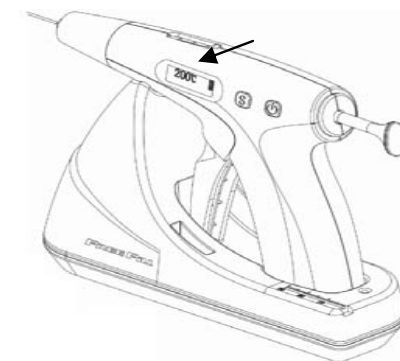

Slit for gutta-percha

For inserting gutta-percha (use medical forceps)

⚠ Notice: When filling is finished, if necessary, please clean up the inner gutta-percha, otherwise it will influence the push of the plugger for next operation.

SECTION 5: INSTALLATION AND SETTING



S

Setting temperature for heating needle. 150°C、180°C、200°C、220°C



POWER

Extended press (2-3 seconds) for switching on/off the device, short press for starting/stopping the heating. Device will power off automatically when heating more than 15 minutes or no operation in 5 minutes.

⚠ Remarks

After temperature setting finished, please short press the POWER button to start heating.

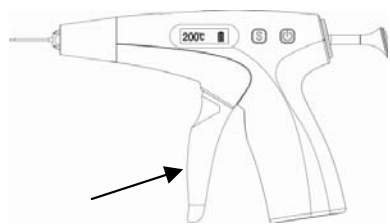

Trigger

Pushing the plunger to inject the gutta-percha

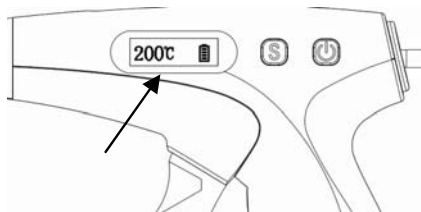

LCD display

Set temperature, heating temperature display and battery status display.



-----Warning-up



-----Energy-saving function

Power status:



-----Low battery



-----Full power





-----Cleaning status, constant temperature is 100°C, quit cleaning function by press any button.



-----Energy-saving status, constant temperature is 120°C, quit this function when hold the inductive switch or press button "S"(this mode can be shut off manually)

⚠ Remarks

When "⚡" changed to "E1" means heating malfunction, "E2" means warming-up malfunction. With the device off, extended press button POWER until 2 beeps, energy saving function can be turned on or off. It

doesn't show  for turning on the device when this function is off, you can check if the  is showed on the status bar when turning on the device.

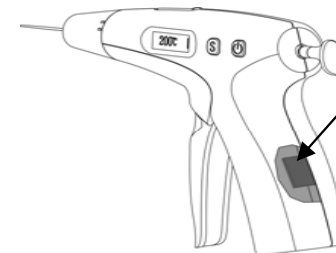

Inductive switch

In the handshake position, the system is equipped with inductive switch. The sense of the switch should be timely and accurate to detect if the doctor's hand is holding or loosening the device in order to save the energy and raise the

temperature quickly.



Needle Nut

Fix the injection needle

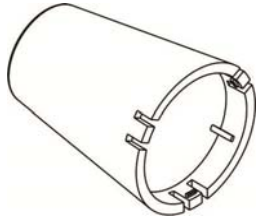

Heat Insulator

Cut off the heat to avoid scalding the patient's mouth.

⚠️ Notice: Install it before injection and please to avoid long term heat. Remove the insulator after injection. Please fill out the charge and remove

heat protective sleeve. **Alternate use is recommended and avoid direct contact with the human body.**

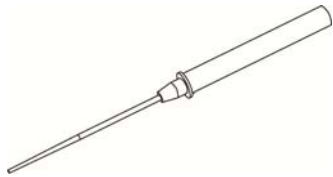

Injection Needle

Used for injecting melted gutta-percha.

⚠️ Notice: 1.The needle can not be rotated and twisted at will

2.Bend it by special tool as below

3.Loosen the nut when rotary motion needed

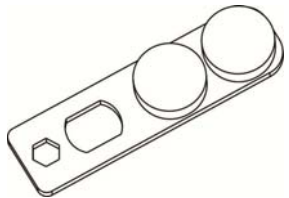

Tool

Fasten or loosen the nut, bend the injection needle

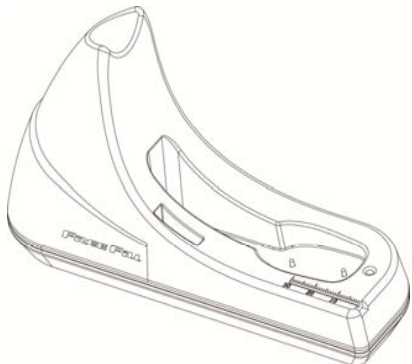

Charging base

Place and charging the injection device

1)Use adapter as 7.5V 2.5A

2)After the adapter power is connected, the charging lamp shows the red and green alternately to indicate that the battery is to be charged (not charged)

3)Place the injection device onto the charging base with the trigger inward (match well the charging electrode) ,the charging lamp is red and bright

4)The power is full when the charging lamp is green.

⚠️ Remarks

The charging base is not waterproof, the liquid contact electrode is forbidden, and the conductor is forbidden to contact the charging thimble.

A. Heating pen/ FreeFill Obturation Pen

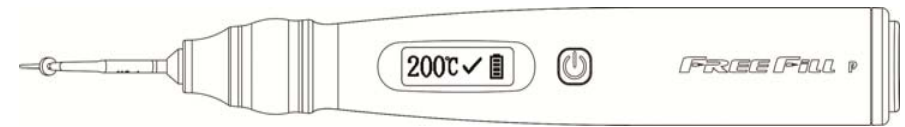

Heating pen

special equipment for cutting gutta-percha point and press the gutta-percha vertically inside of the root canal



POWER

Extended press POWER for switching on/off, short press for shifting temperatures(150°C、180°C、200°C、220°C), it will switched off 5 minutes later without any operation.

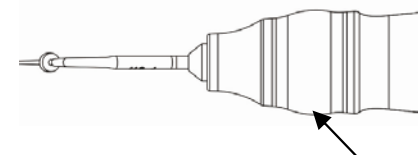

operation.

Heating ON/OFF switch button

360°press button, heating starts when press the button and stops when loose the button, shows "⚡" during normal

⚠ Remarks

When "⚡" changed to "E1" means heating malfunction, please check your heating needle.

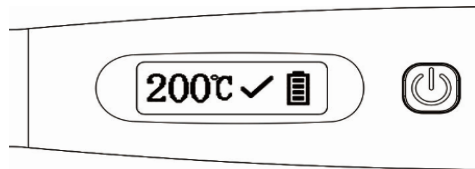
**LCD display**

Shows preset temperature or real-time temperature. Middle shows the heating needle status:
"√"heating needle connected,
"×"heating needle broken or no

needle.

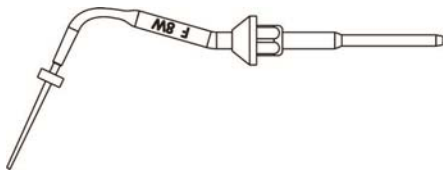
**Heating Tips**

Type F,FM,M,ML 4 pcs in total

⚠ Notice: Rotary, twist and strong tug is forbidden

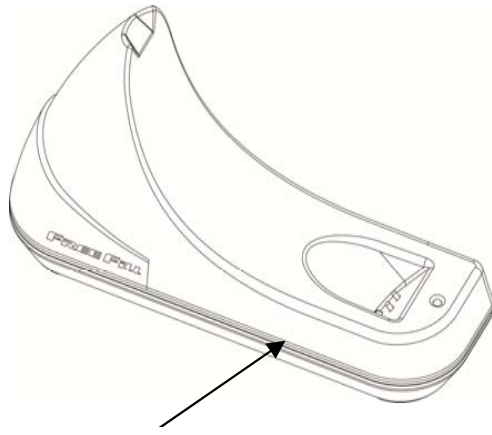
**Charging base**

Place and charging the heating pen
1)Use adapter as 7.5V 2.5A
2)After the adapter power is connected, the charging lamp shows the red and green alternately to indicate that the battery is to be charged (not charged)
3)Place the heating pen onto the charging base with the button inward (match well the charging

Charging lamp
lamp is red and bright 4)The power is full when the charging lamp is green.

⚠ Remarks

The charging base is not waterproof, the liquid contact electrode is forbidden, and the conductor is forbidden to contact the charging thimble.

SECTION 6: INSTRUCTION OF OPERATION

It's important to keep following points to use this system efficiently and to avoid any mechanical trouble or dangerous condition.

Before using GP Obturation System, the dentists need to make good root canal preparation with endo motor.

Requirement for good root canal preparation:

1. All the root canal should be made as straight as possible.
2. Root canals especially small collateral root canals should be cleaned as clean as possible.
3. The dentists must possess root canal cleaner like sodium hypochlorite and had better get a ultrasonic root canal cleaning device to make root canal clean and smooth enough for obturation.

During Operation of vertical condensation with obturation pen:

1. The heat tips should be 4-5mm far from apex point of root canal.
2. The heat tips should be fixed with white slide caliper provided after determining the length of root canal.
3. The gutta percha points (cone) should be 0.5-1mm shorter than the length of root canal.
- 4 Root canal perforation should be avoided when heating. This is very very important.
5. All heat tips are easily broken although the quality of heat tips is very good! Heat tips are consumable!

When the dentists use obturation pen, they should be very tender and soft.

During Operation of backfilling with obturation gun:

Injection needles are also very fragile because it is made of silver!

The dentists had better not change angle of needle often, otherwise the needle is easily broken!

They had better confirm two kinds of angle of needle: one is for upper teeth, another is lower teeth.

In this way, the needle will be avoided bending to different angles often.

When running out of battery, the obturation gun can be still used directly with power adapter for heating.

1. Pen tips, gun needles and heat insulators must be sterilized before application and follow the instructions supplied with autoclave unit.

Sterilization cycle is recommended at 121 °C (250 °F) for 30 minutes or 131 °C (270°F) for 25 minutes.

2. The temperature of pen is preset at 120-220°C, and pen tip selection mode is preset at F, FM, M,ML.

Adjust the working temperature and pen tip mode according to working condition and pen tip size.

The maximum temperature of the gun is preset at 200°C. The dentists are free to choose 160-200°C as per the requirements of GP bar with different brand.

3. Because pen has the characteristics of fast heating and cooling please operate is carefully to avoid any accidents caused by burning.

4. The heater of the gun can be burnt out if there is no GP bar in the heating chamber during the operation of the gun. Make sure to load the GP bar before operating the gun.

5. It's recommended to load just one GP bar at a time and to wait some times for pulling the trigger. Because the warmed gutta percha has a little cushion. Pulling trigger with excessive power may damage the groove on the plunger and it maybe the reason that the gutta percha leak from the needle.

A. FreeFill Obturation Gun

The gun is designed to inject warmed gutta percha that is specially formulated into the root-canal directly. It's provides easy and fast filling, but it's recommended to use the pen to fill the apical part at first to avoid any overfilling or under filling and the gun can be used for filling the remained part

of the canal.

1. Select the appropriate injection needle and attach it to the gun. Tighten firmly using the accessory tools provided.

Then put the battery inside the gun.

2. Put the heat insulator in the front of gun, and bend the needle according the condition of the tooth being treated.

3. To load the gutta percha bar, press down the plunger release button and pull the plunger out. There is no need to pull the plunger out completely, it is suggested to pull it out to leave enough space after GP bar loaded.

Please put one GP bar into the loading chamber and further push it into the heating chamber with the use of cotton pliers.

4. Push forward the plunger until the resistance of the gutta percha bar is felt.

5. Extended press the PWR button to start operation of obturation gun, and the display window will appear the dynamic rising temperature process.

⚠ Remarks

※ **After preset the needed temperature, please short press the PWR button to start the heating.**

※ **The FreeFill obturation gun should be slightly downward before starting the work.**

※ **After using the plugger once, we suggest changing the other one. At the same time, please clean the remaining gutta percha in the chamber for use next time.**

※ **Make sure that the gutta percha bar is inserted into the injection needle before heating.**

6. Filling the warmed gutta percha with the gun by pulling a trigger slowly. It needs to wait about two minutes until the gutta percha is warmed properly.

7. After use, remove remained gutta percha in the gun and extended press POWER button for switch off.

8. Remove the needle before the gutta percha is cooled down, it's recommended to use new needle and heat insulator in each application to avoid the infection.

⚠ Remarks

※ **To avoid cross infection, we recommend that you change new or sterilized injection needle and heat insulator every time you use them.**

※ **Please remove the injection needle and plugger before the gutta percha is completely cooled so that it will be convenient for the next operation.**

※ **Please use up gutta percha by one time, that is, all is extruded from the injection needle, to avoid residual gutta percha in the chamber.**

※ **Please do not pull off the plugger before the gutta percha has been fully finished.**

※ **Cleaning mode: The temperature of FreeFill gun is automatically set at 100 degrees for clean mode.**

※ **If the heating lasts for 15 minutes without manual stop heating, then the device automatically stop heating in order to save electricity power.**

※ **When the FreeFill gun is placed for 2 minutes and no one is operating, it automatically enters the energy-saving mode (which can be switched off); In the energy-saving mode, the automatic constant temperature is up to 120°C, and when the hand grasps the gun body again, the original setting temperature is restored, and the automatic heating is carried out. In the energy-saving mode, you can also press the S button to restore heating.**

※ **In the shutdown state, extended press the POWER button, until hearing buzzer sound twice and seeing the screen status change, you can manually switch off or open the automatic energy-saving mode.**

⚠ Remarks

※ **Please ensure that pull the plugger out of working position, the temperature can be reduced to acceptable range (the use of special cleaning mode), and then, open needle nut and remove injection needle to avoid burning.**

B. FreeFill Obturation Pen

The pen is designed for vertical condensation or down packing with warmed gutta percha in the canal. Besides, it can be used to cut off excessive gutta percha point.

1. Dry root canal. Apply a thin layer of root canal sealer to the root canal wall and gutta percha points, then insert the gutta percha points into the root canal.

2. Select the appropriate pen tip and insert it into the pen. Adjust the angle according to the tooth being treated and tighten firmly using the accessory tool provided. Available tip sizes provided are F, FM, M. Adjust the pen tip mode depends on the tip size selected and adjust the working temperature according to working condition. Short press POWER to start the obturation pen.

3. Select the appropriate vertical compression device (hand plugger), with short and steady percussion, press the working end around the root canal, press the tip of the root to squeeze the gutta percha, and clean the root canal wall, so that the material can be flat.

4. Continues to heat pen tips, move slowly inside the root canal, and push the soft gutta percha points downward until within reference point to 2mm (this step is controlled within 5 seconds) with a careful, continuous operation.

⚠ Remarks

※ **As we have stated before, special care is needed to avoid any accidents by burning. The spring switch must be placed in touch-free position at any place.**

5. Stop heating and continue to exert proper downward pressure on the gradually cooled gutta percha points until the rubber stopper reaches the reference point.

6. Maintain a steady root pressure, gently press for 10 seconds, and then heat another 1 seconds, then remove the remaining gutta percha, and press it vertically with vertical compression device (hand plugger).

7. After use, extended press POWER button for switch off, if necessary.
8. Remove the heat tips, clean the device and related accessories for next use.

Remarks

- ※ **During the process of heating, extended press the button of 10S can switch off heating automatically.**
- ※ **Warning Tone: 1 sound for normal operation, 2 for reminder, 3 for incorrect operation or invalid operation.**
- ※ **For the sake of safety, do not allow heat tips to stay in the root canal for more than 5S during the working condition.**

C. Charging System

1. Checking the charging state, when the battery is charging, the indicator light shows red color, when the battery is fully charged, the indicator light shows green.
2. When the battery is charging or stop using, please do not put it near metal in order to avoid the short circuit of the machine.
3. Please do not use other adapter if the adapter is damaged, please contact with distributor or manufacturer for solution!

Remarks

- ※ **1) Heat tips, injection needles and heat insulator must be sterilized before use;**
- ※ **2) Because of the rapid warming and cooling characteristics of the FreeFill pen, special care is needed to avoid any accidents by burning;**
- ※ **3) The FreeFill gun can enter the root canal after heating, and pay attention to prevent it from being burned by injection needle;**
- ※ **4) The FreeFill gun is forbidden to pull the trigger when gutta percha bar is inserted, but the heating function is not turned on, so as to avoid mechanical trouble.**

SECTION 7: APPLICATION OF ROOT CANNAL FILLING

First-Phase Preparation

- 1) Gutta percha point (Master cone)

Select the appropriate gutta percha point as a master cone which has same taper and size with prepared root canal. Shorten 0.5-1 mm of the point than working length to avoid overfilling and to secure enough space to fill additional point.

2. Hand plugger

Prepare 2-3 hand plungers to compact the filled gutta percha.

3. Pen tips

Select the appropriate pen tip and sign the working length by using callipers, The signed working length should be 5-7 mm short than the length of root canal and make sure the pen tip size will not touch the root canal.

4. Pen tips

Please select the appropriate size of pen tip according to the thickness at the 2/3 position of root canal coronal.

A. Vertical Condensation/Down Pack

1. Dry the root canal, apply a thin layer of root canal sealer on the root canal wall, and put the GP cone in position.
2. Confirm the working length, warm the selected pen tip and cut off excess GP cone.
3. Put the gutta percha cone inside the root canal and then push it slowly into the apex by using warmed pen tip until the pen tip is 5-7 mm from the apex then stop warming the pen tip. (The whole process should be finished in 7-9 seconds)
4. Softly press the gutta percha cone for 10 seconds, warm the pen for 1 second again, and take out residual gutta percha cone. Compact the warmed gutta percha by using the hand squeezing device.
5. If the root canals need to place the post pin, the backfilling process can be omitted, leaving enough space for the post pin. If not, backing filling it with obturation gun.

B. Backfilling

1. Put the gutta percha bar inside the heating chamber and then forwarding the plunger to the front until no move can be felt. Then warm the gutta percha bar to the setting value.
2. After the gutta percha has been warmed up and then insert the injection needle of the gun as far as it will go into the canal space without binding.
3. Activate the trigger and inject the warmed gutta percha into the canal until orifice by feeling the injected gutta percha push the tip out of the canal.
4. Compact the warmed gutta percha firmly by using the hand squeezing device.
5. Repeat previously mentioned 3-4 procedures until the entire canal is filled completely.
6. Confirm obturation with a radiograph.

SECTION 8: CLEANING & MAINTANANCE**A. FreeFill Obturation Gun**

It's recommended that the gun should be cleaned after every use to prevent built-up of excess gutta percha in the cylinder.

1. Adjust the unit into operating temperature. Press the plunger release button and pull the plunger out. Using a towel to wipe off gutta percha found on the plunger.
2. Turn the unit off and unplug the power cord. Let the gun be cooled before cleaning.
3. Insert the plunger and re-assemble the obturation gun.

B. FreeFill Obturation Pen

Clean the tips regularly with the use of a towel with the cleaning solution provided. Do not open the pen handpiece in any case.

If you want to clean the pen tip during operation (Heating state), please use dried towel, do not use wet cleaning solution.

SECTION 9. TROUBLE SHOOTING

TROUBLES	CHECK
Can not be recharged	Check the power indicator
	Check that the adapter and charging base are connected properly
	Check that the battery and charging base are connected properly
No reaction after pressing button PWR	Check that the adapter and power socket are connected properly
	Check that battery is no-power.
	Please try to press button extendedly
Pen tip does not heat.	Check that the installation of battery is correct
	Check that the battery is in good order
	Check that pen tips are in good order.
No GP coming out of injection needle	Check that activate heating operation
	Check that pen tips are firmed properly
E1 for FreeFill Gun	Check that injection needle is blocked. If yes, clean the injection needle or change the new one.
	Check that the temperature comes up to the required degree.
E2 for FreeFill Gun	Restart the device, if happen again, please contact the local dealer or manufacturer
E1 for FreeFill Pen	Please check if the battery is sufficient in power. If the electricity power is enough, please contact the local dealer or manufacturer
	Heat tips may burn out, please replace the heat tips, if it can not be solved, please contact the local dealer or manufacturer

It's not recommended to open or disassemble the control unit, pen and gun in any case and manufacturer or local dealer does not have any responsibility on problems or troubles caused by opening or

disassembling the units by unauthorized person.

If there are any questions or suggestions, please feel free to contact sales representative.

SECTION 10. ENVIRONMENTAL REQUIREMENTS

OPERATING CONDITIONS

Ambient temperature: 5°C ~ 40°C

Relative humidity range: ≤80%

Atmospheric pressure: 70kPa~ 106kPa

STORAGE AND SHIPPING CONDITIONS

Ambient temperature: -40°C ~ 55°C

Relative humidity range: ≤80%

Atmospheric pressure: 50kPa ~ 106kPa

Equipment is not suitable for storage in the presence of sunlight, rain, dust, and corrosive gasoline and volatile without poor ventilation.

Transportation is applicable to all common method.

SECTION 11. PACKING LIST

Complete Set of Obturation System Include (Standard list):

Obturation Gun	1 PC	Obturation Pen	1 PC
Injection Needle	1 Pack	Pen Tip	1 Pack
Charging Base	2 PCS	Brush	1 PC
Adapter	2 PCS	Accessory Tool	1 PC
Heat Insulator	2 PCS	Extra Plugger	1 PC
GP Bar	1 Pack	English Manual	1 PC

SECTION 12. WARRANTY STATEMENT

The device is maintained free of charge and doesn't require any routine maintenance within warranty period.

Do not modify and disassemble the device.

This instrument described below has been fully inspected and confronts to the current products specification.

The control part is guaranteed for its designated use, against original defects in materials and workmanship for a period of 12 months from date of purchase. The guarantee for spare parts is 6 months from date of purchase.

Products warranty or service will not be extended if (1) the product is repaired, modified, misused, disassembled, or using the parts are not provided by the manufacturer, (2) The serial number of the product is defaced or missing.

The guarantee for accessories is 6 months. All accessories of the device are damaged or needed to be renewed, the user can purchase new accessories from the seller.

WARNING

The device is not repairable by user and contains no user serviceable parts. No modification of this equipment is allowed.

The user must check that the equipment functions safely and see that it is in proper working condition before being used.

The manufacturer does not require such preventive inspections by other persons.

Please contact the sales distributor directly from whom you purchase this device for user's record and further after-sale service.

Table 1

Guidance and manufacturer's declaration - electromagnetic emissions
--

The [DY-GP Plus] is intended for use in the electromagnetic environment specified below. The customer or the user of the [DY-GP Plus] should assure that it is used in such an environment

Emissions test	Compliance	Electromagnetic environment - guidance
RF emissions CISPR 11	Group 1	The [DY-GP plus] uses RF energy only for its internal function. Therefore, its RF emissions are very low and are not likely to cause any interference in nearby electronic equipment.
RF emissions CISPR 11	Class [B]	The [DY-GP Plus] is suitable for use in all establishments other than domestic, and may be used in domestic establishments and those directly connected to the public low-voltage power supply network that supplies buildings used for domestic purposes, provided the following warning is heeded: Warning: This equipment/system is intended for use by healthcare professionals only. This equipment/ system may cause radio interference or may disrupt the operation of nearby equipment. It may be necessary to take mitigation measures, such as re-orienting or relocating the [DY-GP Plus] or shielding the location.
Harmonic emissions IEC 61000-3-2	Class A	
Voltage fluctuations/ flicker emissions IEC 61000-3-3	Complies	

Table 2

Guidance and manufacturer's declaration - electromagnetic emissions
The [DY-GP Plus] is intended for use in the electromagnetic environment specified below. The customer or the user of the [DY-GP Plus] should assure

that it is used in such an environment

Immunity Test	IEC 60601 Test level	Compliance level	Electromagnetic environment - guidance
Electrostatic discharge (ESD) IEC 61000-4-2	±6 kV contact ±8 kV air	±6 kV contact ±8 kV air	Floors should be wood, concrete or ceramic tile. If floors are covered with synthetic material, the relative humidity should be at least 30 %
Electrical fast transient/burst IEC 61000-4-4	±2 kV for power supply lines ±1 kV for input/output lines	±2 kV for power supply lines	Mains power quality should be that of a typical commercial or hospital environment. The electrical fast transient burst (EFT) is generated by the switching of inductive loads. Separation between the equipment and other loads shall be considered before installation. Mains filter is required, if necessary.
Surge IEC 61000-4-5	±1 kV line(s) to line(s) ±2 kV line(s) to earth	±1 kV line(s) to line(s)	Mains power quality should be that of a typical commercial or hospital environment.
Voltage dips, short interruptions and voltage variations on power supply input lines IEC 61000-4-11	<5% U _T (>95% dip in U _T) for 0.5 cycle 40% U _T (60% dip in U _T) for 5 cycle 70% U _T	<5% U _T (>95% dip in U _T) for 0.5 cycle 40% U _T (60% dip in U _T) for 5 cycle 70% U _T	Mains power quality should be that of a typical commercial or hospital environment. If the user of the [DY-GP Plus] requires continued operation during power mains interruptions, it is recommended the [DY-GP Plus] be powered from an uninterruptible

	(30% dip in U_T for 25 cycle <5% U_T (>95% dip in U_T) for 5s	(30% dip in U_T for 25 cycle <5% U_T (>95% dip in U_T) for 5s	power supply or a battery.
Power frequency (50/60Hz) magnetic field IEC 61000-4-8	3 A/m	3 A/m	Power frequency magnetic fields should be at levels characteristic of a typical location in a typical commercial or hospital environment.
NOTE U_T is the a.c. mains voltage prior to application of the test level.			

Table 3

Guidance and manufacturer's declaration - electromagnetic emissions			
The [DY-GP Plus] is intended for use in the electromagnetic environment specified below. The customer or the user of the [DY-GP Plus] should assure that it is used in such an environment			
Immunity Test	IEC 60601 Test level	Compliance level	Electromagnetic environment - guidance
Conducted RF IEC 61000-4-6	3Vrms 150KHz to 80MHz 3 V/m	3V 3 V/m	Portable and mobile RF communications equipment should be used no closer to any part of the [DY-GP], including cables, than the recommended separation distance calculated from the equation applicable to the frequency of the transmitter. Recommended separation distance

Radiated RF IEC 61000-4-3	80MHz to 2.5GHz	<p>$d=1.2 \sqrt{P}$</p> <p>$d=1.2 \sqrt{P}$ 80MHz to 800MHz</p> <p>$d=2.3 \sqrt{P}$ 800MHz to 2.5GHz</p> <p>where P is the maximum output power rating of the transmitter in watts (W) according to the transmitter manufacturer and d is the recommended separation distance in metres (m) Field strengths from fixed RF transmitters, as determined by an electromagnetic site survey,^a should be less than the compliance level in each frequency range.^b Interference may occur in the vicinity of equipment marked with the following symbol:</p> 
NOTE 1 At 80 MHz and 800 MHz, the higher frequency range applies. NOTE 2 These guidelines may not apply in all situations. Electromagnetic propagation is affected by absorption and reflection from structures, objects and people.		
^a Field strengths from fixed transmitters, such as base stations for radio (cellular/cordless) telephones and land mobile radios, amateur radio, AM and FM radio broadcast and TV broadcast cannot be predicted theoretically with accuracy. To assess the electromagnetic environment due to fixed RF transmitters, an electromagnetic site survey should be considered. If the measured field strength in the location in which the [DY-GP Plus] is used exceeds the applicable RF compliance level above, the [DY-GP Plus] should be observed to verify normal operation. If abnormal performance is observed, additional measures may be necessary, such as re-orienting or relocating the		

[DY-GP Plus].
^b Over the frequency range 150 kHz to 80 MHz, field strengths should be less than 3 V/m.

Table 4

Recommended separation distances between portable and mobile RF communications equipment and the [DY-GP Plus]			
The [DY-GP Plus] is intended for use in an electromagnetic environment in which radiated RF disturbances are controlled. The customer or the user of the [DY-GP Plus] can help prevent electromagnetic interference by maintaining a minimum distance between portable and mobile RF communications equipment (transmitters) and the [DY-GP Plus] as recommended below, according to the maximum output power of the communications equipment.			
Rated maximum output power of transmitter W	Separation distance according to frequency of transmitter m		
	150kHz to 80MHz $d=1.2 \sqrt{P}$	80MHz to 800MHz $d=1.2 \sqrt{P}$	800MHz to 2.5GHz $d=2.3 \sqrt{P}$
0,01	/	0.12	0.23
0,1	/	0.38	0.73
1	/	1.2	2.3
10	/	3.8	7.3
100	/	12	23

For transmitters rated at a maximum output power not listed above, the recommended separation distance d in metres (m) can be estimated using the equation applicable to the frequency of the transmitter, where P is the maximum output power rating of the transmitter in watts (W) according to the transmitter manufacturer.

NOTE 1 At 80 MHz and 800 MHz, the separation distance for the higher frequency range applies.

NOTE 2 These guidelines may not apply in all situations. Electromagnetic propagation is affected by absorption and reflection from structures, objects and people.

WARRANTY REGISTRATION FORM

Item Name: _____

Model Name: _____

Serial No.: _____

Date of Purchase: _____

Name: _____

Address: _____

Phone: _____

Email: _____

Name of Distributor: _____

Authorized Distributors: _____

Stamp and Signature